

Implementation of a Waste Filtration Control System and Monitoring of Waste Quality in an Internet of Things-Based Laundry Business

Elisabeth Priska Pi'o^{a1}, I Made Agus Dwi Suarjaya^{a2}, Putu Wira Buana^{b3}

^aDepartment of Information Technology, Faculty of Engineering, Udayana University
Bukit Jimbaran, Bali, Indonesia-8036110

e-mail: ¹lilispriska04@gmail.com, ²agussuarjaya@it.unud.ac.id, ³wb@unud.ac.id

Abstrak

Sistem kontrol penyaringan air limbah berbasis Internet of Things (IoT) dirancang untuk pemantauan kualitas air secara real-time dan mengatur proses penyaringan secara otomatis. Sensor pH, turbidity, dan Total Dissolved Solids (TDS) digunakan untuk mendeteksi kualitas air limbah pada aktivitas laundry. Data dari sensor dikirimkan melalui mikrokontroler Arduino dan ESP8266 ke Firebase, lalu ditampilkan pada aplikasi Android. Berdasarkan hasil pengukuran sensor, sistem akan mengaktifkan pompa penyaringan atau mengalirkan air ke saluran pembuangan atau penampungan sesuai dengan kondisi air. Hasil pengujian menunjukkan bahwa sistem mampu meningkatkan kejernihan air dengan tingkat keberhasilan sebesar 70% dari sepuluh sampel uji. Sistem juga terbukti dapat mengirimkan data ke Firebase dan aplikasi Android dengan stabil dan waktu pengiriman yang singkat. Solusi ini berpotensi diterapkan pada skala kecil, khususnya dalam pengelolaan air limbah rumah tangga dan usaha laundry.

Kata Kunci: IoT, penyaringan air limbah, ESP8266, Firebase, Android.

Abstract

An Internet of Things (IoT)-based wastewater filtration control system is developed to monitor water quality in real-time and automatically manage the filtration process. pH, turbidity, and Total Dissolved Solids (TDS) sensors are employed to detect the quality of wastewater generated from laundry. This section presents the results of the design and implementation stages of the waste filtration control system and Internet of Things-based water quality monitoring. activities. Sensor data is transmitted via Arduino and ESP8266 microcontrollers to Firebase, then displayed through an Android application. Based on the sensor readings, the system activates the filtration pump or channels the water to either a drainage outlet or a storage tank depending on the water condition. Test results indicate a 70% success rate in producing cleaner water from ten tested samples. The system also demonstrates stable and fast data transmission to Firebase and the Android application. This solution is suitable for small-scale applications, especially for household and laundry wastewater management.

Keywords: IoT, wastewater filtration, ESP8266, Firebase, Android.

1. Introduction

Laundry business is one form of service that is growing rapidly in various regions, especially in urban areas that have a high level of mobility. Large-scale washing activities carried out by laundry businesses generate significant volumes of wastewater [1]. This waste contains various harmful chemical compounds, such as detergents, bleaches, softeners, and phosphates, which if discharged directly into the environment without treatment will cause serious pollution to soil and water sources [2].

The increasing demand for clean water in a region like Bali, especially in Badung Regency, is exacerbated by the threat of a water deficit in the coming years. Groundwater sources that have been used to meet the needs of the community are threatened by the infiltration of household and industrial waste, including laundry waste [3]. Therefore, wastewater treatment is one of the important efforts to maintain the sustainability of water resources and environmental sustainability.

The main problem faced in laundry waste management is the lack of a system capable of filtering and monitoring water quality automatically and in real-time [4]. Most laundry businesses still discharge waste without an adequate filtration process. In addition, the inefficient manual monitoring system makes it difficult for business owners to know the quality of the discharged water, which can lead to violations of environmental quality standards [5].

Along with the development of technology, the Internet of Things (IoT) provides innovative solutions in waste management [6]. Internet of Things technology allows integration between sensors, microcontrollers, and software to monitor and control processes automatically. In this research, an IoT-based laundry wastewater quality filtering and monitoring system is implemented using a combination of pH, turbidity, and TDS sensors, as well as Arduino microcontrollers and NodeMCU ESP8266 connected to Firebase and Android applications as monitoring media.

In addition to the monitoring system, a water filtration method is also used using a specially designed biosand filter tube with a combination of filter materials such as activated sand, activated carbon, zeolite, and palm fiber [7]. This combination aims to reduce the level of turbidity, pH, and other dissolved substances in wastewater. The sensor measurement results become the basis of the system in determining whether the water will be channeled to the sewer or to the re-shelter basin, as well as activating the pump automatically according to the water condition [8].

Previous research by Primantara (2021) entitled "Internet of Things-Based Water and Air Quality Monitoring System" shows the implementation of IoT in environmental quality monitoring, using a combination of sensors for water and air, as well as Arduino Uno and NodeMCU ESP8266 boards. The system is also equipped with GPS and is capable of displaying data in real-time through mobile applications and websites [9].

Meanwhile, Pratama (2021) in his research titled "Weather Monitoring System on Lakes Based on the Internet of Things" developed a water and weather quality monitoring system using Arduino and Raspberry Pi. The system is capable of displaying data in real-time, but it is not yet equipped with an automatic control system for water treatment [10].

Unlike previous studies that only focused on monitoring, this research combines a wastewater quality monitoring system with an IoT-based automatic water filtration control system. The system was developed using water quality sensors (pH, TDS, turbidity, temperature), Arduino Uno, and NodeMCU ESP8266 connected to Firebase and an Android app. Additionally, the system can automatically activate pumps or water valves based on sensor readings, enabling intelligent water filtration without manual intervention.

This research aims to design and implement an automated IoT-based wastewater filtration and quality monitoring control system. The system is expected to provide a practical and efficient solution to help laundry businesses manage wastewater in an environmentally friendly manner and in accordance with applicable water quality standards.

2. Research Method

The method used in this study is the Research and Development (R&D) method, which aims to design, develop, and test an Internet of Things (IoT)-based wastewater quality control and monitoring system. The research was conducted in several systematic stages, starting from problem identification, data collection, system design, tool development, testing, to system evaluation and improvement. Each stage is carried out gradually to ensure that the system built can work according to the plan and research needs.

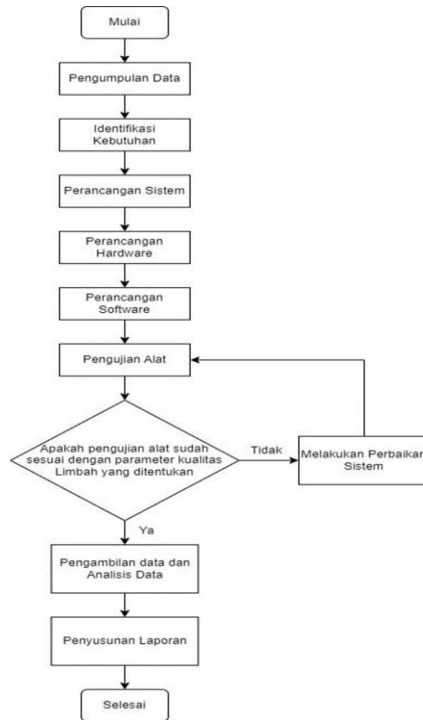

Figure 1. Flowchart Implementation of R&D Method

Figure 1 is a flowchart that illustrates the research process, beginning with problem identification and literature review to strengthen the theoretical basis and problem formulation. The next stage is system design, which includes hardware and software design, including the integration of water quality sensors (pH, TDS, temperature, turbidity) with Arduino microcontrollers and NodeMCU ESP8266. After the design is complete, the system is implemented and the device is tested to ensure that the monitoring and automatic control functions work as expected. The final stage includes analyzing the test results and evaluating the system's performance, which forms the basis for drawing conclusions and recommendations for further development.

3. Literature Study

This section describes the theoretical foundations and previous research results that form the basis for the system design. The literature review covers the characteristics of laundry waste, environmental and health quality standards, Internet of Things (IoT) technology, and the hardware components and sensors used in the system.

3.1 Laundry Waster

Wastewater from laundry is wastewater that originates from the washing of clothes in laundries, households, hotels, or other industries. This wastewater contains various chemicals such as detergents, bleach, and fragrances that can damage the environment if disposed of without being treated first. A study conducted by (Kusuma, Dimas A, 2021) shows that laundry wastewater has the following characteristics: COD 910.5 mg/L, BOD 441 mg/L, TSS 48.65 mg/L, pH 8.6, and phosphate content of 38.24 mg/L [11]. Therefore, it is important to ensure that the wastewater meets the quality standards set by the government.

To determine whether wastewater is suitable for discharge into the environment, reference is made to the quality standards for wastewater set forth in official government regulations. Two commonly used regulations are Bali Governor Regulation No. 16 of 2016 for environmental standards and Ministry of Health Regulation No. 2 of 2023 for environmental health standards [12], [13]. Below is a summary of the contents of these two standards.

Table 1. Wastewater Quality Standards for Domestic Businesses and/or Activities

Parameter	Unit	Maximum Permissible Level
Suspended solids (turbidity)	mg/L	200
Total dissolved solids (TDS)	mg/L	2000
pH	mg/L	6 - 9
Free chlorine	mg/L	100
BOD	mg/L	50
COD	mg/L	80
Phosphate	mg/L	5
Oil and grease	mg/L	10
Temperature	°C	38

Source: Bali Governor Regulation (2016) and PERMEN LHK RI Number: P.68/Menlhk/Setjen/Kum.1/8/2016

This table shows the maximum permissible limits for key parameters in domestic wastewater before it is discharged into the environment. If test results exceed these values, the wastewater is considered to be polluting the environment and must be treated first.

Table 2. Environmental Health Quality Standards (SBMKL) for Hygiene and Sanitation Purposes

Parameter	Unit	Maximum Permissible Level
Microbiology		
<i>Escheriachia coli</i>	CFU/100ml	0
Total Coliform	CFU/100ml	0
Physical		
Temperature	°C	Air temperature +- 3
Total dissolved solids (TDS)	mg/L	<300
Turbidity	NTU	<3
Color	TOU	10
Taste	-	-
Odor	-	Odorless
Chemical		
pH	-	6.5-8.5
Iron	mg/L	0,2

Fluoride	mg/L	-
Hardness	mg/L	-
Manganese	mg/L	0,1
Nitrate	mg/L	20
Nitrite	mg/L	3
Cyanide	mg/L	-
Detergent	mg/L	-
Total Pesticides	mg/L	-

Source: Appendix to Minister of Health Regulation No. 2 of 2023 concerning Environmental Health Quality Standards for Water for Hygiene and Sanitation Purposes

This table is used to assess whether filtered water is suitable for hygiene and sanitation purposes. These standards are stricter than environmental standards because they are intended to directly protect human health.

3.2 Waste Management

Waste management aims to reduce pollutant content so that it is safe to dispose of into the environment. This process can be carried out using physical, chemical, or biological filtration methods [8]. One commonly used method is filtration or screening.

A biosand filter is a waste filtration system that uses layers of media such as silica sand, zeolite, activated carbon, sand, gravel, cotton, and sponge [14]. This media functions to capture harmful particles in water in layers. This process is effective in reducing turbidity, pH, and TDS.

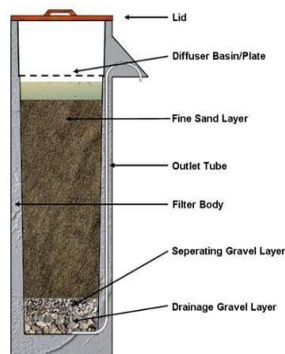

Figure 2. Biosand Filter

3.3 Internet of Things (IoT)

The Internet of Things (IoT) is a technological concept that enables physical devices such as sensors, actuators, and microcontrollers to connect to each other via the internet to exchange data without direct human intervention [15]. This technology is the foundation of modern automation systems because it enables the collection, transmission, and processing of data to be carried out in real-time and in an integrated manner. In this context, IoT is used to connect water quality sensors to a cloud-based monitoring system. This technology enables real-time and automatic monitoring.

3.4 pH Sensor

A pH sensor is a device used to determine the acidity or alkalinity of a liquid. The pH value is important for determining whether wastewater is within safe limits before disposal. This sensor produces an analog output that is then converted into a pH value through a program [16].

3.5 Turbidity Sensor

A turbidity sensor is a device that detects the level of turbidity in water, expressed in NTU units. It works by reading the light scattered by particles in the water. The higher the NTU value, the higher the level of turbidity in the water [17].

3.6 TDS Sensor

The TDS (Total Dissolved Solids) sensor measures the amount of dissolved solids in water. This value is important for determining the quality of wastewater. High TDS indicates contamination from chemicals or minerals [18].

3.7 DS18B20 Temperature Sensor

The DS18B20 temperature sensor detects water temperature with high accuracy. This sensor uses the 1-Wire digital communication protocol. Temperature values are used as supporting parameters in wastewater quality evaluation [19].

3.8 HC-SR04 Ultrasonic Sensor

Ultrasonic sensors are utilised to determine the level of water in a storage container. These devices work by utilising the reflection of ultrasonic sound waves. The data obtained is then used to regulate the logic system in the water filling and discharge process [20].

3.9 Arduino Uno R3

The Arduino Uno is the main microcontroller used to read data from sensors and control actuators. Arduino is programmed using Arduino IDE. This board is easy to use and compatible with various sensors [21].

3.10 NodeMCU ESP8266

NodeMCU ESP8266 is used as a connector between Arduino and Firebase. This module has WiFi connectivity to send sensor data in real-time. In addition, NodeMCU can also be programmed for simple decision making [22].

3.11 4-Channel Relay

The 4-channel relay is utilized as an electronically controlled switch to regulate water pumps based on sensor conditions. This module enables the Arduino to safely control highvoltage devices. Each relay channel is connected to a different device, such as a pump or water valve [23].

3.12 Arduino IDE

Arduino IDE is software used to program Arduino and NodeMCU. This IDE supports various sensor libraries and streamlines the process of uploading code to microcontrollers. In this study, Arduino IDE was used to develop an automatic monitoring and control system [24].

4. Result and Discussion

This section presents the results of the design and implementation stages of the waste filtration control system and Internet of Things-based water quality monitoring. The description begins with system design, an overview of the system, hardware assembly, and software implementation. The results presented include flowcharts, system block diagrams, and evaluation of test results for the components and software developed.

4.1 System Flowchart Design

System flowchart design begins with the preparation of a general system flowchart to illustrate the basic logic of the system from start to finish. This flowchart serves as the main guide in the implementation of the automatic monitoring and control system.

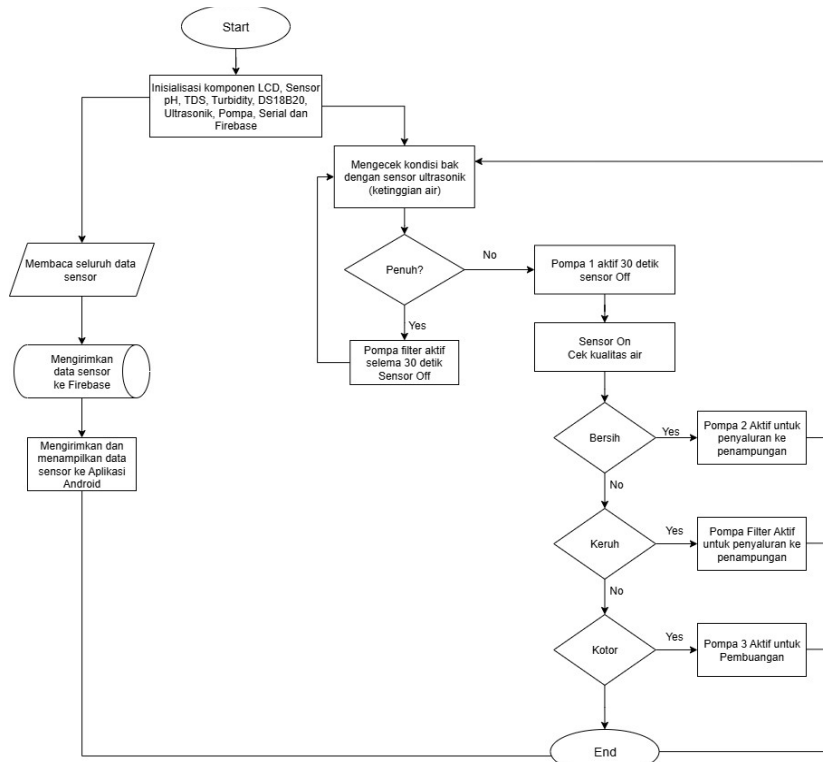

Figure 3. General System Flowchart

In the flowchart, the system begins by reading all sensor data such as pH, temperature, turbidity, TDS, and water level. These sensor values are then compared with predefined threshold values. Based on these conditions, the system will activate the filtration pump, the pump to the storage tank, or divert the water to the wastewater storage area. After that, the data is sent to Firebase and displayed in real-time on the Android application.

4.2 System Overview

A system block diagram is a conceptual representation that explains the relationships between components without detailing their technical specifications. This diagram shows how data flows and system logic works from the sensor to the user application.

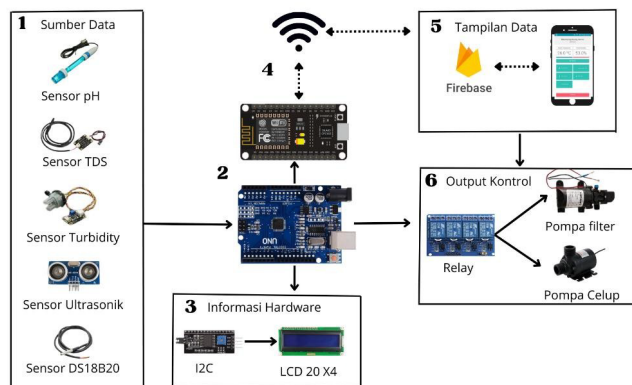

Figure 4. System Block Diagram

The figure above is a block diagram of an Internet of Things (IoT)-based wastewater monitoring and filtration system. The system begins with data reading by five types of sensors, namely pH, TDS, turbidity, ultrasonic, and DS18B20 temperature sensors, which serve as data

sources (block 1). The sensor data is sent to the Arduino Uno microcontroller (block 2) for processing, and some of the information is displayed locally via a 20x4 LCD module using I2C communication (block 3). The data is then sent serially to the NodeMCU ESP8266 (block 4), which is responsible for sending the data to Firebase and displaying it in the Android app in real-time (block 5). Based on the sensor readings, the Arduino Uno also controls a 4-channel relay to automatically regulate the filter pump and submersible pump (block 6).

4.3 Electronic Circuit System

The electronic circuit is designed by integrating all components such as sensors, Arduino Uno, NodeMCU, relays, LCD, and power sources. This circuit is the core of the system that allows all components to work in an integrated manner.

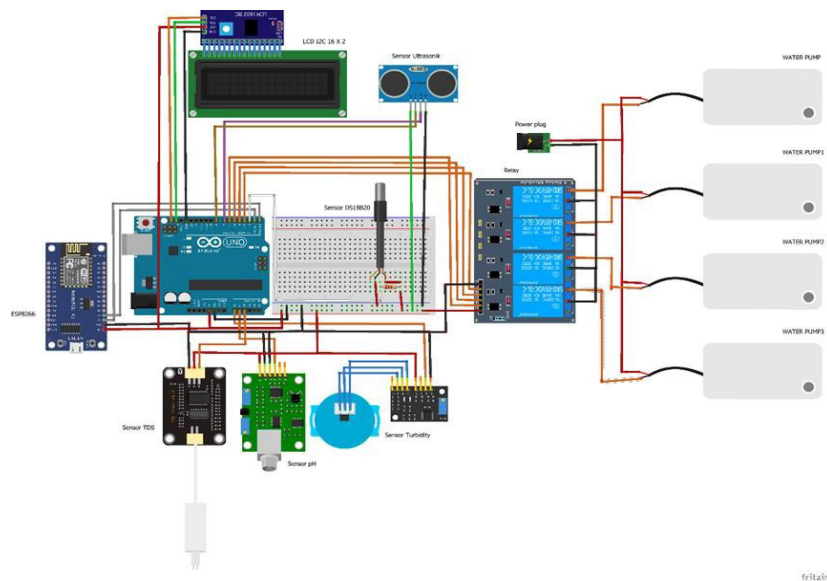

Figure 5. Electronic Circuit System

The image above shows the entire electronic system consisting of various sensors, microcontrollers, and actuators. The Arduino Uno microcontroller functions as the data processing center for the pH, TDS, turbidity, temperature (DS18B20), and ultrasonic sensors, each of which is connected via analog and digital pins. The sensor values read are displayed locally via a 16x2 I2C LCD and sent to the NodeMCU ESP8266 via serial communication to be forwarded to Firebase. The system also controls a 4-channel relay module connected to four water pumps (filter pump and drain pump) that operate automatically according to the detected water conditions. The circuit is designed such that all components can operate synchronously and efficiently in the process of filtering and monitoring the quality of laundry wastewater.

4.4 Hardware System Implementation

The device design was carried out by assembling components into a single laundry waste filtration device. Implementation was carried out in physical form with two filtration tanks and a modular control system.



Figure 6. Implementation of the Laundry Wastewater Filtration Device

The image above shows the physical implementation of the laundry wastewater filtration and monitoring system as a whole. The system consists of two main tanks that function as initial and final reservoirs, as well as a biosand filter tube that is used for the gradual filtration of wastewater. The filter pump is used to transport wastewater from the lower storage tank to the filter tube, while the submersible pump is used to transport the filtered water to the initial storage tank, distribution to the clean water storage tank, and wastewater disposal. The entire water distribution flow is automatically controlled by an IoT-based system that responds to data from water quality sensors. The electronic components, including the Arduino Uno, NodeMCU, and relays, are neatly arranged at the bottom of the system to support efficient and safe operation of the equipment.

4.5 Software System Implementation

The software implementation in this system consists of two main parts, namely the use of Firebase Realtime Database as cloud storage, and an Android application as the user monitoring interface. Firebase is used to receive and store sensor data sent serially via NodeMCU ESP8266. The Android application connects directly to Firebase and displays sensor data in real time in an informative and easy-to-understand display.

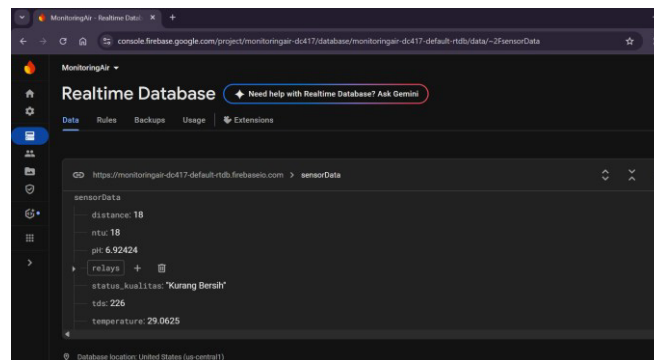

Figure 7. Firebase Realtime Database Display

Firestore displays the sensorData structure containing water quality parameters such as pH, TDS, turbidity (NTU), temperature, and distance (water level). Additionally, Firestore stores information on water quality status and relay status as part of actuator control. The data displayed is real-time and automatically updated every time the NodeMCU receives new data from the Arduino.

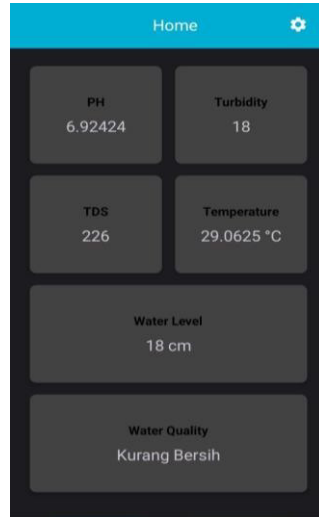

Figure 8. Android Application Display for Water Quality Monitoring

The Android application display presents data in a grid format showing each sensor value, such as pH: 6.92, TDS: 226 ppm, turbidity: 18 NTU, temperature: 29°C, and water level: 18 cm. There is also an information label “Water Quality: Kurang Bersih” as the system's evaluation of the water condition. With this display, users can monitor water quality directly and quickly via a mobile device without needing to physically inspect the equipment.

4.6 System Evaluation

The system evaluation was conducted based on three main aspects, namely pump action based on water quality, pump action based on water level, and filtration system effectiveness. This evaluation aimed to determine the extent to which the system could operate automatically based on water conditions detected by sensors.

Table 3. Evaluation of Pump Action Based on Water Quality

No.	Testing Scenario	Expected Output	Test Results	Evaluation
1.	The system detects water that is not clean enough.	Main pump active to perform filtration	Active pump filter	Already compliant
2.	The system detects that the water is still not clean enough and runs an additional filtration process.	Main pump active to perform advanced filtration	Active pump filter	Already compliant
3.	The system detects that the water quality has improved but is still not clean enough.	Main pump active to perform advanced filtration	Active pump filter	Already compliant
4.	The system detects clear water.	Pump 2 active to channel water to the reservoir	Pump 2 active	Already compliant
5.	The system detects dirty water and runs a disposal process.	Pump 3 is active to perform the disposal process	Pump 3 active	Already compliant

6.	The system detects dirty water and runs a disposal process.	Pump 3 is activated to channel water to the disposal	Pump 3 active	Already compliant
7.	The system detects water that falls into the category of not clean enough.	The main pump is activated to perform filtration	Active filter pump	Already compliant
8.	The system detects water that falls into the clear category	Pump 2 is activated to channel water to the reservoir	Pump 2 active	Already compliant
9.	The system detects clear water	Pump 2 is active for the reservoir	Pump 2 active	Already compliant
10.	The system detects clear water	Pump 2 is active for channeling to the reservoir	Pump 2 active	Already compliant

The table shows that the system successfully responds to water quality conditions based on NTU and TDS values by activating the appropriate pump. When water is detected in a dirty condition (high NTU and high TDS), the system activates Pump 3 to discharge water outside. If the water is in the less clean category, the filter pump is activated to perform further filtration. When the water is deemed clear, pump 2 is activated to supply water to the final storage tank. The system's response aligns with the programmed control logic and demonstrates consistency across each testing cycle.

Table 4. Pump Action Evaluation Based on Water Level

No.	Test Scenario Expected Output	Test Scenario Expected Output	Test Results Evaluation	Test Results Evaluation
1.	Water almost full Filter pump active	Water almost full Filter pump active	Active filter pump Compliant	Active filter pump Compliant
2.	Water starting to empty Filter pump active	Water starting to empty Filter pump active	Active filter pump Compliant	Active filter pump Compliant
3.	Water empty Filter pump off, pump 1 active	Water empty Filter pump off, pump 1 active	Active pump 1 Compliant	Active pump 1 Compliant
4.	Water almost full Filter pump active	Water almost full Filter pump active	Active filter pump Compliant	Active filter pump Compliant
5.	Water almost full Filter pump active	Water almost full Filter pump active	Active filter pump Compliant	Active filter pump Compliant
6.	Water medium Filter pump active	Water medium Filter pump active	Active filter pump Compliant	Active filter pump Compliant
7.	Water empty Filter pump off, pump 1 active	Water empty Filter pump off, pump 1 active	Active pump 1 Compliant	Active pump 1 Compliant
8.	Water full Filter pump active	Water full Filter pump active	Active filter pump Compliant	Active filter pump Compliant
9.	Water almost empty Filter pump active	Water almost empty Filter pump active	Active filter pump Compliant	Active filter pump Compliant

10.	Water empty Filter pump off, pump 1 active	Water empty Filter pump off, pump 1 active	Active pump 1 Compliant	Active pump 1 Compliant
-----	--	--	----------------------------	----------------------------

Based on testing results, the system can regulate pumps based on water level in the storage tank. The ultrasonic sensor detects the water level and activates the filter pump when the water is nearly full or being filled. Meanwhile, when the water reaches the empty limit (approximately 21 cm), Pump 1 is activated to refill the tank. This evaluation shows that the water level control system operates automatically and effectively in maintaining water volume balance during the filtration cycle.

Table 5. Wastewater Filtration System Result

Testing	NTU		NTU Difference	TDS		TDS Difference
	Before	After		Before	After	
1.	40	11	29	344	195	149
2.	29	10	19	288	117	171
3.	49	30	19	315	212	103
4.	27	10	17	300	220	80
5.	49	28	21	325	240	85
6.	30	10	20	295	198	97
7.	35	9	26	305	162	143
8.	24	10	14	310	178	132
9.	33	10	23	290	168	122
10.	38	8	30	280	193	87
Average Reduction			21,7			116,9
Success Percentage						70% Clear (7/10 data)

The effectiveness of filtration was evaluated by comparing NTU and TDS values before and after the filtration process. Out of ten tests, there was an average decrease of 21.7 in NTU and 116.9 in TDS. Seven out of ten samples showed that the water was in the clear category after filtration (NTU ≤ 10 and TDS ≤ 300), so the filtration system's success rate reached 70%. Although not all samples met the clear standard, all of them still experienced a significant decrease in terms of clarity and dissolved substances, proving that the filtration system was working quite well.

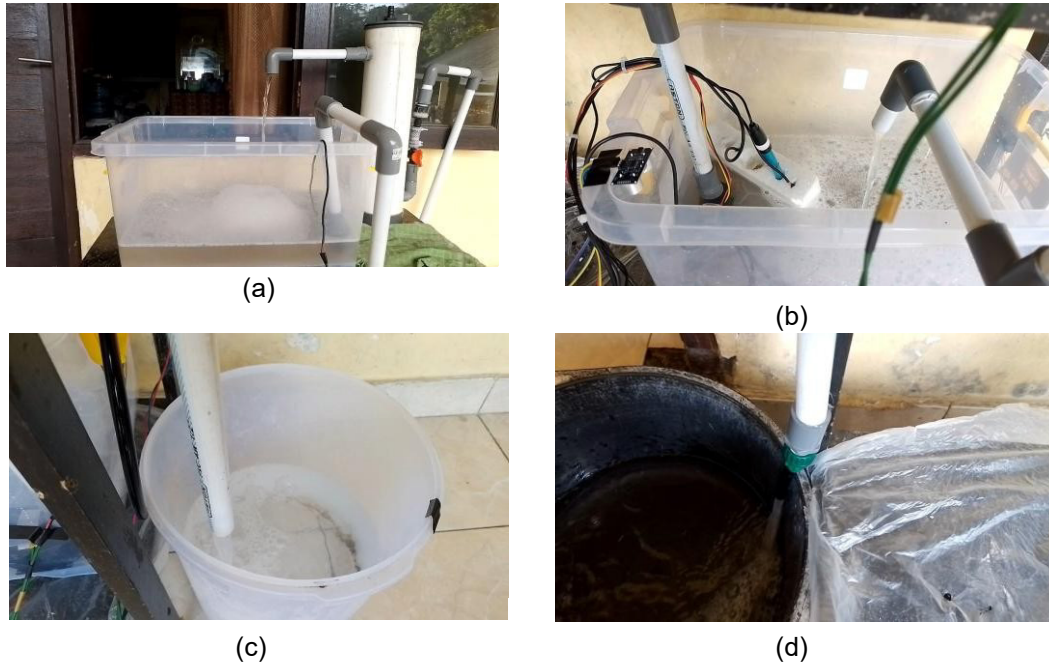

Figure 9. Display of Pump Test Results

Figure 9 documents the results of testing the pump action system based on water quality. Figure (a) shows the condition when the filter pump is successfully activated, indicating that the system has detected water in the unclear category. At this stage, water from tank 1 is pumped to tank 2 to undergo the filtration process. Next, Figure (b) shows that pump 2 is successfully running, pumping water from tank 2 back to tank 1, indicating that the system is testing the circulation of filtered water. Figure (c) shows the condition when pump 2 is active again, but this time pumping water to the final storage tank, as the system detects that the water has reached a clear and usable status. Finally, Figure (d) shows Pump 3 active for draining water, meaning the detected water falls into the dirty category based on NTU or TDS values exceeding the predetermined threshold.

5. Conclusion

This study successfully designed and implemented an efficient Internet of Things (IoT) based laundry waste filtration and quality monitoring control system. The system uses turbidity, pH, temperature, and TDS sensors connected to Arduino Uno and NodeMCU ESP8266, and sends data in real time to Firebase to be displayed on an Android application. The system is also capable of automatically controlling pumps and valves based on sensor values, with decision-making logic tailored to water conditions whether for filtration, distribution, or waste disposal. Test results indicate that the system effectively filters waste, with 70% of samples achieving the "clear" category, and data transmission occurs quickly and stably. This system can be further developed by adding monitoring graph features, a notification system, and manual control via the Android app. Regular sensor calibration and direct testing in a laundry business environment are also recommended to enhance the system's accuracy and validity in real-world conditions.

References

- [1] Nyoman Santi, N., Kepala Pusat Pengendalian Pembangunan Ekoregion Bali dan Nusa, P., Jawab, P., Kepala Bidang Inventarisasi Daya Dukung Daya Tampung SDA dan Lingkungan Hidup, Ms., Istri Muter Handayani, C., Kepala Sub Bidang Pertambangan, Ms., Kelautan, dan, Damar Windu Kurniawan, W., Pendidikan Ganesha Gusti Lanang Made Parwita, Ms.-U. I., & Negeri Bali, M.-P. (n.d.). Tim Penyusun Pengarah.
 - [2] Jayanto, G. D., Widyastuti, M., & Hadi, M. P. (2021). Laundry wastewater characteristics and their relationship with river water quality as an indicator of water pollution. Case study: Code Watershed, Yogyakarta. E3S Web of Conferences, 325. <https://doi.org/10.1051/e3sconf/202132502011>
 - [3] Harmayani, K. D. (n.d.). Evaluasi Kinerja Instalasi Pengolahan Air Limbah Rsd Mangusada Kabupaten Badung.
 - [4] Gemala, M., dkk. (2019). Rancang Bangun Air Limbah Laundry dengan Media Penyaringan Arang Aktif dan Pasir Zeolit. Skripsi. Fakultas Teknik, Universitas Negeri Surabaya.
 - [5] Apriyani, N. 2017. Penurunan Kadar Surfaktan dan Sulfat dalam limbah Laundry. Media Ilmiah Teknik Lingkungan Volume 2 Nomer 1, 37-44
 - [6] Apriyani, N., & Novrianti, N. (2020). Penggunaan Karbon Aktif Dan Zeolit Tak Teraktivasi Dalam Alat Penyaring Air Limbah Laundry. Jukung (Jurnal Teknik Lingkungan), 6(1). <https://doi.org/10.20527/jukung.v6i1.8240>
 - [7] Sinaga, M. S., Astuti, S. W., & Gultom, E. (2020). Degradation of phosphat in laundry waste with biosand filter method. IOP Conference Series: Materials 91 Science and Engineering, 801(1). <https://doi.org/10.1088/1757899X/801/1/012067>
 - [8] Kadek Widianara, I., Budiarsa Suyasa, W., & Diara, W. (2018). Implementasi Biosistem Untuk Pengolahan Air Limbah Laundry. 12.
 - [9] Primantara, (2021). Sistem Monitoring Kualitas Air dan Udara Berbasis Internet of Things. Skripsi. Fakultas Teknik, Program Studi Teknologi Informasi, Universitas Udayana.
 - [10] Pratama, (2021). Sistem Monitoring Cuaca pada Danau Berbasis Internet of Things. Skripsi. Fakultas Teknik, Program Studi Teknologi Informasi, Universitas Udayana.
 - [11] Kusuma, D. A., Fitria, L., & Kadaria, U. (2019). Pengolahan Limbah Laundry Dengan Metode Moving Bed Biofilm Reactor (MBBR). In Jurnal Teknologi Lingkungan Lahan Basah (Vol. 02, Issue 1).
 - [12] <https://id.scribd.com/document/727916724/LAMPIRAN-PERMENKES-RI-NOMOR-2TAHUN-2023>, diakses tanggal 13 Juli 2025.
 - [13] <https://jdih.baliprov.go.id/produk-hukum/peraturan-perundang-undangan/pergub/28765>, diakses tanggal 13 Juli 2025.
 - [14] Nailufhar, Lili. 2018. Efektifitas Daya Adsorpsi Kombinasi Adsorben Zeolit, Karbon aktif, dan Pasir dalam Pengolahan Limbah Cair Laboratorium Agroindustri FPTK UPI Bandung. Bandung. Universitas Pendidikan Indonesia.
 - [15] Kumar, D., Kumar, S., & Anand, P. (2022). Internet of Things Based Real Time Monitoring and Control of Industrial Waste Water. Proceedings of 5th International Conference on Contemporary Computing and Informatics, IC3I 2022, 1312–1317. <https://doi.org/10.1109/IC3I56241.2022.10072643>
 - [16] Kadek Widianara, I., Budiarsa Suyasa, W., & Diara, W. (2018). IMPLEMENTASI BIOSISTEM UNTUK PENGOLAHAN AIR LIMBAH LAUNDRY. 12.
 - [17] D. Sasmoko, H. Rasminto, and A. Rahmadani, "Rancang Bangun Sistem Monitoring Kekeuruhan Air Berbasis IoT pada Tandon Air Warga," J. Inform. Upgris, vol. 5, no. 1, pp. 25–34, 2019, doi: 10.26877/jiu.v5i1.2993.
 - [18] Noor, A., Supriyanto, A., Rhomadhona, H., Jurusan), Informatika, T., Negeri, P., Laut, T., Km, J. A. Y., Kabupaten, P., & Selatan, K. (2019). Aplikasi Pendeteksi Kualitas Air Menggunakan Turbidity Sensor Dan Arduino Berbasis Web Mobile. Jurnal CoreIT, 5(1).
 - [19] Wiguna, P., Hannats, M., Ichsan, H., & Fitriyah, H. (2018). Rancang Bangun Filter Air Berbasis Arduino Pada Penampungan Air Menggunakan Metode Fuzzy (Vol. 2, Issue 10). <http://j-ptiik.ub.ac.id>
-

- [20] Hartanto, S., & Eko Fitriyanto, R. (2019). Rancang Bangun Sistem Saluran Kran Air Otomatis Berbasis Arduino ATMEGA328P. *Jurnal Ilmiah Elektrokrisna*, 7(3).
 - [21] Arafat, G. F., Wijayanto, A., & Prasetyo, N. A. (2022). Rancang Bangun Sistem Monitoring Pengolahan Limbah Cair Tahu Di Kabupaten Purbalingga Berbasis Internet of Things. *Jurnal Media Informatika Budidarma*, 6(3), 1329. <https://doi.org/10.30865/mib.v6i3.3863>
 - [22] Bayuguna, A. A. G. (2020). Sistem Kontrol dan Monitoring Tanaman Hidroponik Berbasis Internet of Things. Skripsi. Fakultas Teknik, Program Studi Teknologi Informasi, Universitas Udayana.
 - [23] Aditama, I. P. D. R. (2024). Rancang Bangun Sistem Sensor Suhu Wireless dengan DHT11 dan MQTT Berbasis Internet of Things. Skripsi. Fakultas Teknik, Program Studi Teknologi Informasi, Universitas Udayana.
 - [24] Rahman, M. W., Islam, R., Hasan, A., Bithi, N. I., Hasan, M. M., & Rahman, M. M. (2022). Intelligent waste management system using deep learning with IoT. *Journal of King Saud University - Computer and Information Sciences*, 34(5), 2072–2087 <https://doi.org/10.1016/j.jksuci.2020.08.016>
-